Volute Pump

Model: LS2 / LS

LS2-e / LS-e

Warning

Do not carry out operation, inspection or maintenance of the pump until you read this manual and understand the content.

Keep this manual carefully at hand so that it can be consulted at anytime when operating, inspecting or maintaining the pump.

For contractors who carry out equipment work:

Please be sure to deliver this manual to the customer who will operate, inspect or maintain the pump.

Limited warranties

1. In the event of a failure or breakage under proper use of the product during the warranty period, equipment supplied by Teral Inc. shall be repaired or replaced free of charge within the scope of the relevant part, provided that such failure or breakage is attributable to inadequacy of the design or workmanship of the equipment.
The warranty period of this product shall be one year after the date of delivery.
2. The warranty mentioned in the above clause shall be only the mechanical warranty of the defective part, and shall not cover any expenses or other damage arising from the failure or breakage. Moreover, the warranty is available for Japan domestic use only.
3. In the event of the following failures and breakage, the costs of the repairs shall be borne by the user.
 - (1) Failures and breakage attributable to equipment that was not delivered by Teral Inc.
 - (2) Failures and breakage after the expiration of the warranty period
 - (3) Failures and breakage caused by disasters or force majeure, such as fire, acts of God, or earthquakes
 - (4) Failures and breakage resulting from repairs or modifications made without the consent of Teral Inc.
 - (5) Failures and breakage when parts other than those designated by Teral Inc. are used
 - (6) Failures and breakage caused by use or storage outside the specification range
4. Teral Inc. shall not be liable for the damage caused by incorrect or reckless use of the pump. Cost and expenses incurred for sending engineer(s) in such a case shall be borne by the user.
5. If the cause of the failure is unclear, necessary actions shall be determined through mutual consultation.

Purpose of this manual

The purpose of this manual is to provide the user with detailed information necessary to properly operate, maintain and inspect the pump. Incorrect operation of this product may lead to an unexpected accident.

Please use the product correctly according to this instruction manual.

This manual contains the following information and is intended for persons experienced in the operation of pumps, or for those who have been trained by such experienced operators. Only qualified personnel such as licensed electrical engineers are allowed to carry out the electrical wiring work.

Contents

	(Page)
Limited warranties	I
Purpose of this manual	II
Contents	II
1. Safety precautions.....	1-1
1.1 Types and meanings of safety signs and graphic symbols.....	1-1
1.2 Safety precautions.....	1-1
1.3 Location of warning labels and caution labels.....	1-4
2. Configuration and overview of the pump.....	2-1
2.1 Model type description	2-1
2.2 Part names and functions.....	2-1
2.3 Standard specifications	2-2
3. Installation	3-1
3.1 Before using the pump	3-1
3.2 Precautions for installation	3-1
3.3 Installation procedure	3-3
3.4 Coupling alignment procedure	3-4
3.4.1 Alignment (CF-A type coupling).....	3-5
3.4.2 Alignment (AB type coupling)	3-7
3.5 Precautions for piping work.....	3-8
3.6 Precautions for wiring work.....	3-11
4. Operation.....	4-1
4.1 Check items before test operation.....	4-1
4.1.1 Check items related to the electrical system	4-1
4.1.2 Check items related to the pump.....	4-1
4.2 Running the pump (test operation).....	4-2
5. Maintenance and inspection.....	5-1
5.1 Precautions for maintenance and inspection	5-1
5.2 Shaft seal parts.....	5-2
5.2.1 Gland packing.....	5-2
5.2.2 Mechanical seal	5-3
5.3 Bearings	5-3
5.4 Maintenance checklist.....	5-4
6. Troubleshooting.....	6-1

1. Safety precautions

Before using the unit, thoroughly read this “Safety precautions” to properly use the product. Information described below is vital to safe and proper use of the unit and prevention of hazard and/or damage.

1.1 Types and meanings of safety signs and graphic symbols

This instruction manual divides precautions into the following four categories according to the level of hazards (or the severity of the accident). In addition, prohibited or mandatory actions as well as cautions are indicated with a graphic symbol.

Be sure to understand the meanings of the following terms and comply with the content (instructions) of the instruction manual.

■ Explanation of warnings

Safety sign	Meaning
	Indicates an imminently hazardous situation. Failure to observe this will result in death or serious injury.
	Indicates a potentially hazardous situation. Failure to observe this will result in death or serious injury.
	Indicates a potentially hazardous situation. Failure to observe this will result in minor or moderate injury or property damage.
	Indicates information that is in particular to be noted or emphasized.



























■ Explanation of the graphic symbols

















	Don'ts		Do not touch		Do not disassemble		Do not touch with wet hand		Do not expose to water
These graphic symbols indicate prohibited actions (that must NOT be done).									
	Do's	This graphic symbol indicates mandatory actions (that must be done).							
	Caution		Electric shock hazard		Rotation hazard		Hot surface		
These graphic symbols indicate existing hazards to beware of.									

1.2 Safety precautions

Danger	
	Once the main power is turned on, do not touch any live parts. A high voltage applied to live parts may cause a serious electric shock, thus leading to death.



























Warning	
Properly move the unit according to lifting instructions. Otherwise, the unit may fall, thus leading to an injury or damage.	Do not carry out any work with/on the pump that is being lifted. Otherwise, the unit may fall, thus leading to an injury or damage.
Only those who are authorized by the site manager are allowed to operate the pump. Operation by unskilled personnel may lead to an unforeseen accident.	Installation, maintenance, and inspection must only be carried out by personnel who have been trained to handle the pump. Operation by unskilled personnel may lead to an unforeseen accident.
Only qualified personnel, such as licensed electrical engineers, are allowed to carry out electric work. Otherwise, it may lead to an electric shock, fire, failure, or other problems.	Use high-quality wiring equipment and devices, and carry out wiring work safely and securely according to the technical standards for electrical facilities, as well as the indoor wiring regulations. Otherwise, it may lead to an electric shock, fire, or other problems.
Securely install the ground wire and ensure to carry out grounding work. Otherwise, it may lead to an electric leak or electric shock.	Be sure to install the leakage circuit breaker at the main power supply. Otherwise, it may lead to an electric shock or fire.

 Warning	
 Correctly and securely connect the wires according to the wiring diagram within the terminal box and the instruction manual.  Incorrect wiring may cause a fire, electric shock, failure, or other problems.	 Do not connect the ground wire to a gas pipe or water pipe. Such a connection is illegal and leads to an electric shock, explosion, or fire.
 Check the wiring sections and wires for any looseness.  A loose connection may cause a fire or electric shock.	 Do not run the unit if abnormal condition is observed in any operation, movement, parts, etc. Otherwise, it may lead to an injury, failure, or various accidents.
 Before starting the unit or carrying out maintenance/inspection work, ensure that all the relevant workers are informed of the operation and that there are no workers in the dangerous zone. Otherwise, it may lead to an unforeseen accident.	 Before starting the maintenance or inspection work, be sure to stop the pump and turn off the main power of the panel board.  Otherwise, it may lead to an electric shock, injury, damage, or leakage.
 Before rotating the main shaft by hand to check its smooth rotation, be sure to turn off the main power.  Otherwise, it may lead to an injury.	 In the event of a power failure, be sure to turn off the power switch.  Otherwise, the pump may suddenly start up on restoration of the power, thus leading to an injury.
 Be sure to put a shaft coupling protective cover during operation.  Otherwise, it may lead to an injury or damage.	 Be sure to keep the terminal box cover attached during the operation of the pump.  Otherwise, it may lead to an electric shock.
 After turning on the power, do not touch any parts of the pump other than those required for operation.  Otherwise, it may lead to an electric shock or injury.	 Do not perform zero-discharge operation for more than one minute continuously.  Otherwise, the temperature and pressure may increase inside the pump, thus damaging the pump or causing steam to blow off.
 Do not put your fingers or foreign objects into any openings or rotating part of the motor during operation.  Otherwise, it may lead to an injury or damage.	 For overhaul, replacement of parts, or repairs, contact Teral or the service center specified by Teral.  If unskilled personnel carry out work that requires special knowledge, it may lead to an accident or failure.
 Do not use the product in any explosive atmosphere. Otherwise, it may lead to any injury or fire.	

 Caution	
 Do not use the unit outside the range of the product specifications.  Otherwise, it may lead to an electric shock, fire, leakage, failure, or other problems.	 Check that the delivered items are exactly what you ordered. The use of a wrong product may cause an injury or failure.
 Do not modify the pump. Any accident or damage due to the modification by customer is beyond our warranty.	 Do not run the pump at a frequency exceeding 60 Hz (50 Hz for models dedicated to 50Hz). Otherwise, it may lead to motor burnout or a fire.
 Do not use a single pump unit as the only means of directly operating key facilities or sustaining life. In the event of a failure, the water supply may stop. Ensure to make a backup unit available for operation.	 Do not give the product any physical shock during transportation, transfer, and installation. Otherwise, it may cause damage to the product.
 Ensure that the floor at the unit's installation place is waterproofed and fitted with drainage. Otherwise, it may lead to serious damage in the event of leakage.	 Do not use the unit at an incorrect power voltage. An incorrect voltage may damage the motor.
 When two or more pumps are installed together, every pump should have its own separate suction piping. Otherwise, it may lead to an abnormal operation.	 Strictly observe the precautions for installation on pump installation environment. Otherwise, it may lead to quick damage of the pump.
 Do not step on the pump, motor, wiring and piping. Otherwise, it may lead to an injury, damage, or other problems.	 Before unpacking the delivered container, check that the container is placed in the correct orientation (not upside down). Carefully unpack the container, while paying special attention to nails. Otherwise, it may lead to an injury or damage.
 Operate the controls carefully. Otherwise, it may lead to an injury or damage.	 Do not install two or more different cables or control wires in one pipe or duct. Otherwise, it may lead to malfunction of the product or other equipment.



Caution

 <p>Before operation, thoroughly clean (flush) the inside of the piping to remove foreign matter. Otherwise, the piping system may be contaminated with foreign matter, thus leading to an accident or a pump failure.</p>	  <p>Do not expose the motor to water. Otherwise, it may lead to an electric shock, electric leak, failure, or other problems.</p>
  <p>Do not put a cloth or other covering on the motor. Otherwise, it may lead to overheating or ignition.</p>	 <p>Do not place any obstacles around the product that may hinder ventilation. Otherwise, it may lead to a fire.</p>
  <p>Do not touch the motor body while the pump is running or immediately after the pump has stopped. Otherwise, you may get burns from the hot surface.</p>	 <p>Never run the pump dry (no-discharge operation) or with insufficient amount of priming liquid. Otherwise, it may cause damage to the sliding part of the pump.</p>
 <p>Do not run the pump with tools or other objects placed on the unit. Otherwise, it may lead to an injury or damage.</p>	 <p>In the event of an alarm or abnormal condition that cannot be resolved, immediately stop the operation, turn off the power, and then contact Teral or its service provider. Otherwise, it may lead to an accident.</p>
 <p>Be sure to install a strainer at the suction side of the pump. Otherwise, foreign objects may enter into the piping and thus cause damage to the sliding parts of the pump.</p>	 <p>Be sure to conduct inspection according to the Maintenance checklist. Otherwise, you cannot prevent potential failures, thus leading to a higher risk of accidents.</p>
  <p>Do not touch the motor if the liquid used exceeds 40 °C. Otherwise, it may lead to a fire</p>	 <p>Once you turn off the power, wait until the pump stops completely. Do not restart the pump until it does. Otherwise, the main shaft may be subjected to an excessive load, which makes the service life of the pump shorter.</p>
 <p>Do not place any combustibles around the product. Otherwise, it may lead to an injury or damage.</p>	 <p>Minimize the frequency of startups and shutdowns of the pump (Max. 5 times per hour). Otherwise, it may lead to quick damage of the pump.</p>
 <p>Ensure to install an overcurrent protective device. The user is required by the technical standards for electrical facilities to install one. Otherwise, it may damage the product, thus leading to a fire or failure. It is also recommended to install protective devices such as a ground fault interrupter.</p>	 <p>When you lift the product by hand, pay attention to its weight. Do not allow a single person to lift a product heavier than 15 kg. Otherwise, it may put strain on the body, thus leading to an injury.</p>
 <p>Before lifting the product, refer to the catalog, dimensional drawing, and other documents to check the weight of the product. Do not lift the product if its weight exceeds the rated load of the hoisting devices. Otherwise, the product may topple over or fall, thus leading to an injury.</p>	 <p>Whenever disassembly and inspection of the pump, replace the packing and O-ring. Otherwise, it may lead to liquid leakage.</p>
 <p>Before disassembly, be sure to close the suction/discharge valve and drain the high-pressure water in the pump/piping. Otherwise, the product may topple over or fall, thus leading to an injury.</p>	 <p>When the pump is not used for a long time, turn off the main power and the pump shall be sufficiently drained for storage. Otherwise, it may lead to liquid leakage.</p>
 <p>Align the shafts correctly. Otherwise, It may lead to damage, vibration or noise.</p>	 <p>Dispose of the product as industrial waste.</p>
 <p>Take the companion flange out of the pump and screw the pipes. Otherwise, It may lead to damage or leakage.</p>	

1.3 Location of warning labels and caution labels

The figure shows the locations of warning labels and caution labels. If these labels become dirty and illegible or if they are peeled off, replace them with a new one.



Observe all the warnings and cautions affixed to the machine as well as those described in this instruction manual.

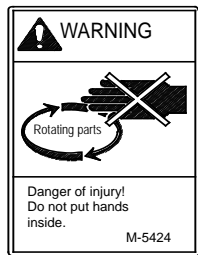
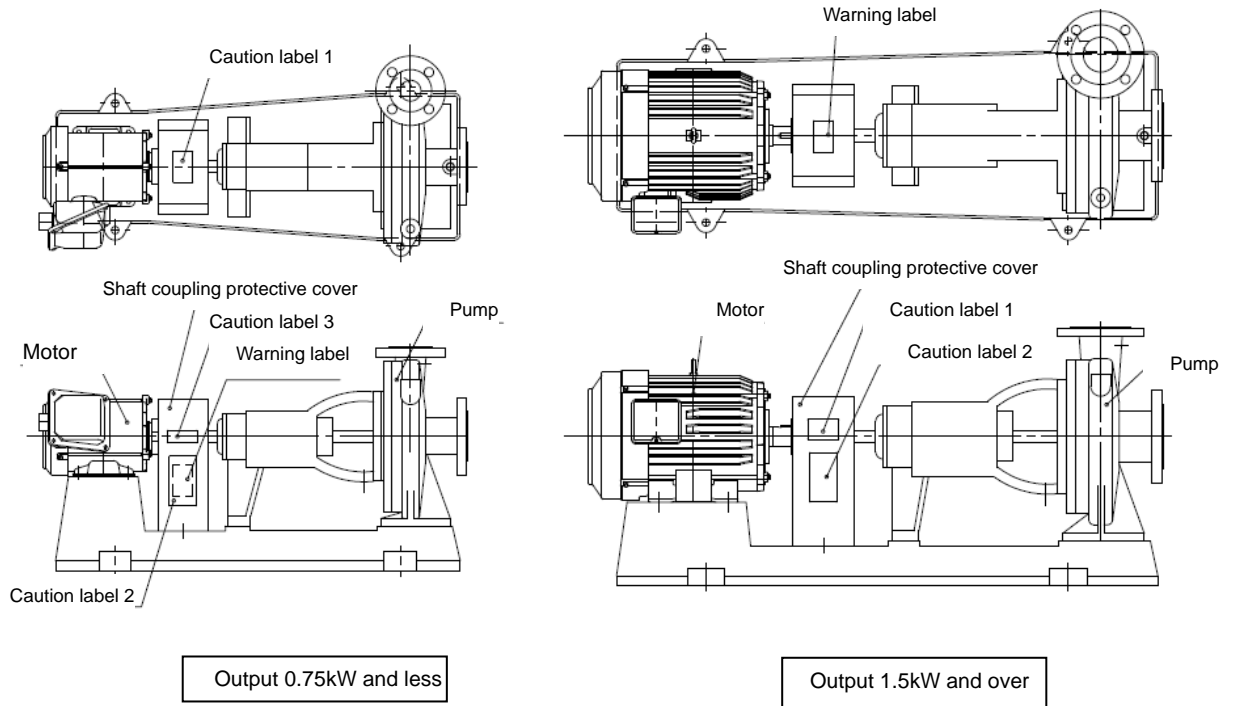

Warning label

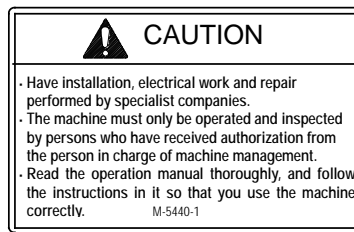

Caution label 1

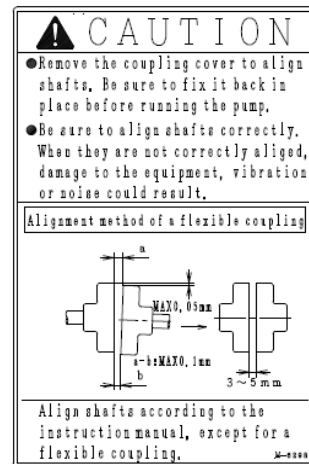

Caution label 2

*The figure shows a typical model.

2. Configuration and overview of the pump

This chapter describes the standard specifications of the pump. If you have purchased a customized product, some information in this chapter may not be applicable to your unit. Refer to the delivery specifications for the details separately.

2.1 Model type description

LS2 50 x 40 A -e
 ① ② ③ ④ ⑤

- ① Model : LS2 (pole : 2P), LS (pole : 4P), LM (pole : 2P, number of stage : 2 stages)
- ② Suction : 50 mm diameter
- ③ Discharge : 40 mm diameter
- ④ Type
- ⑤ Appended to the products with a built-in top runner efficiency (IE3 equivalent) motor

2.2 Part names and functions

① Casing

It connects the pipes. An impeller rotates inside the casing to pressurize the liquid used.

② Motor

③ Common bed

④ Bearing case

It is an oil bath type and the sealed ball bearing is housed in it.

⑤ Shaft coupling

This coupling connects the pump and motor shafts, transmitting the power. It absorbs offset between the centers of the two shafts.

⑥ Shaft coupling protective cover

⑦ Shaft seal part

It prevents water leakage from the shaft penetrating hole. Both of mechanical seal type and gland packing type are available.

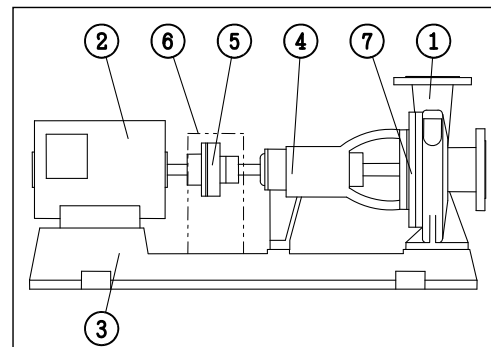





*The figure shows a typical model.



Be sure to put a shaft coupling protective cover during operation. Failure to observe this may lead to an injury or damage.

2.3 Standard specifications

If you have purchased our standard product, refer to the “Standard specifications” table. For details, refer to the specifications including the dimensional drawing and the internal structure drawing. Also if you have purchased a customized product with special specifications, refer to the specifications including the dimensional drawing and the internal structure drawing.

Do not use this product under any conditions other than those provided in the specifications. Failure to observe this may cause an electric shock, a fire, leaks, or failures.

• Standard specifications

Model		LS2/LS2-e		LS/LS2-e		LM/LM-e
		Cast iron	Stainless steel	Cast iron	Stainless steel	Cast iron
Applicable liquid	Quality	Fresh water *1	Corrosive liquid such as acid, alkali	Fresh water *1	Corrosive liquid such as acid, alkali	Fresh water *1
	Temperature	0 to 90°C				
Installation location		Indoors, height above sea level: 1,000m or less; ambient temperature: 0 to 40 °C ; humidity: less than RH85% (no condensing); place not exposed to direct sunlight; place without any corrosive gas, explosive gas, or vapor in the atmosphere				
Total suction head *2 (at water temperature of 20 °C)		Refer to the selection chart in the catalogue				
Allowable boost pressure		0.59MPa or (1.37MPa—shutoff pressure), whichever is lower				0.29MPa
Structure	Impeller	Closed				
	Shaft seal	Gland packing (for special specification : mechanical seal)				
	Bearing	Open ball bearing (oil bath type), Lubricant : Turbine oil #32				
Material		Refer to the specifications including the internal structure drawing				
Motor	Type	Refer to the specifications including the assembly drawing				
	Number of poles	2P		4P		
	Power supply *3	50Hz: 3-phase 200V 60Hz: 3-phase 200V/220V				
Flange standard	Suction	JIS 10K conventional flange				JIS 10K conventional flange
	Discharge					JIS 20K

* 1 Fresh water: 5.8-8.6 pH water without any contaminants (slurry and solids) and of which chloride ion concentration does not exceed 200 mg/L. The water containing chloride ion exceeding 200mg/L may cause corrosion. If the water contains a large amount of corrosive ions, it might not be used for the product. Please contact to your nearest Teral office, if the water has a higher pH value or contains a large amount of chloride ion, hydrogen sulfide ion, fluorine ion, bromine ion, and iodine ion, or it is the special liquid.

* 2 The total suction head indicated in the catalogue shows the values when the water temperature is 20 °C. The maximum value of the total suction head decreases when the pump is used with warm water. The total suction head shows the sum of suction height and suction pipe resistance.

* 3 Limit the fluctuations of the power voltage within $\pm 10\%$ of the rated voltage, and also limit the fluctuations of the frequency between -5% and $+3\%$ of the rated value. Avoid continuous operation if the voltage is not within $\pm 5\%$ of the rated value or if the frequency is not within $\pm 2\%$ of the rated value.

3. Installation

3.1 Before using the pump

Upon receiving the pump, check the following points first.

The container may greatly incline depending on its center of gravity.



Before unpacking, ensure that the delivered container is placed in the correct orientation (not upside down). Pay special attention to nails especially when opening a wooden crate. Otherwise, you may get injured.

Note

After the unpacking, ask the waste-disposal company to dispose of packaging materials that are no longer necessary.

- (1) Check the nameplate to verify that the delivered product is exactly what you ordered.
- (2) No part of the product is damaged during transportation.
- (3) All fastening parts including bolts and nuts are securely tightened.
- (4) All the accessories that you ordered have been delivered.

3.2 Precautions for installation



Observe the precautions for installation in the main text below. Failure to observe this may cause failure or damage. It may also result in shortening the service life of the unit.

- (1) Install the product at a location where the following conditions are all satisfied:
 - A place sheltered from wind and rain
The product is for indoor use. If it is used at outdoors, the place must be sheltered from wind and rain, or specification change is required for outdoor use (special specification). When installing the product for outdoor use, the place must be prevented water from directly entering into the air vent hole of the oil feeding plug.
 - A well-ventilated place at an ambient temperature of 0°C to 40°C with minimum exposure to dust and moisture
 - A place that is free from the exposure to a jet of steam and salt damage
 - A place where the pump cannot easily be accessed or operated by unauthorized persons
 - A place as close to the water supply source as possible so that the suction pipe can be short
Install the pump so that the total suction head will comply with the requirement specified in “2.3 Pump specifications - Standard specifications.” However, the total suction head may be required to be shorter than the requirement depending on the liquid temperature. In general, boost operation is necessary when the liquid temperature is 70 °C or more.
 - A place that is free from a secondary hazard in the event of liquid leakage.



Do not install the product in a place exposed to high temperature and moisture. Failure to observe this may cause heating, ignition or electric leakage.



Install the product so that the total suction head (suction height + suction pipe resistance) is as small as possible within the standard specifications.



Do not install the pump at an upward curve of piping (where air is trapped). Failure to observe this may cause the pump to run dry, and seize up the sliding part in the pump.

- (2) If the pump is used for hot water circulation through closed piping, fit the piping system with an expansion tank, a safety valve, and other devices.
- (3) If the product is used as a circulating pump, attach a sluice valve each to the suction and discharge sides of the pump. It is not necessary to drain water out of the piping at the time of inspection or repair of the pump.
- (4) Using anchor bolts, fix the pump firmly on a level concrete foundation.

Note

Securely fix the pump in place with anchor bolts. Otherwise, it may lead to abnormal vibration or other problems.

- (5) To lift the pump, be sure to pass ropes or other lines through the underside of the common base.



Do not hoist the whole unit using the main shaft of the pump, the lifting harness on the motor, or any other parts not intended for the purpose.



Before lifting the product, refer to the catalog, dimensional drawing, and other documents to check the weight of the product. Do not lift the product if its weight exceeds the rated load of the hoisting devices.

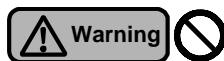

Never use a pump or install parts to it while the pump is lifted. Otherwise, the unit may fall, thus leading to an injury.



When lifting the product, pay attention to its center of gravity. Otherwise, the product may topple over or fall, thus leading to an injury.



When lifting the pump by hand pay attention to its center of gravity and weight. Do not allow a single person to lift a product heavier than 15kg. Failure to observe this may put a burden on the body, thus leading to an injury.

- (6) Ensure to provide a drain ditch around the pump.
- (7) If the system could be exposed to the freezing temperature in winter, ensure to take measures to prevent freezing in the pump room or to prevent the pump, sluice valves, piping, and other devices from freezing.
- (8) Use sound-insulating materials for door and walls of the pump room. Especially if there is a risk that the noise may cause problem, take necessary measures against the noise.
- (9) If the pumping liquid is cold, condensation may occur inside the motor while the pump is stopped. Take measures to prevent condensation, for example, by installing the pump in a sufficiently dry room or by heating and insulating the motor even when the pump is stopped.
- (10) Carry out repair painting at a time interval suitable for the environment of use. Depending on the humidity, condensation, and other conditions, rust may form on areas such as threaded parts, worked areas, anticorrosive-coated sections.
- (11) Do not put a cover or filter over the motor. Failure to observe this may raise the temperature inside the pump, thus leading to product damage, fire, or other problems.

3.3 Installation procedure

- (1) The area and thickness of the foundation concrete must be large enough to withstand the pump weight and the operating load.
- (2) Make foundation holes in advance, according to the drawing or the size of the actual bolts.

Table - Dimensions of Foundation Bolts and Foundation Holes

FD	FL	FB	Wa	H
M10	200	45	100	250
M12	250	55	120	300
M16	315	70	150	370
M20	400	90	190	450

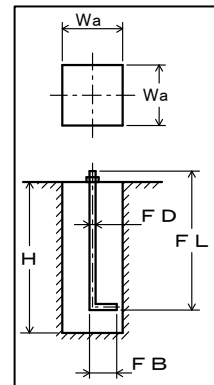

- (3) Ensure that the top surface of the foundation concrete is level, and that the concrete is sufficiently cured before the installation of the pump.
- (4) Place the pump on the foundation concrete. At that time, drive a square steel plate and metal wedges between the common base and the foundation concrete to provide a clearance (about 10 mm to 30 mm) for mortar to be poured into.

Note

The metal wedges are used to adjust the horizontal level of the pump, and also to sustain the pump weight and the operating load. Use as thick a wedge as possible to reduce the total number of pieces. Uniformly place them close to the foundation bolts so that the loads are evenly supported.



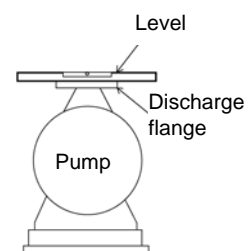

- (5) Fix foundation bolts to the common base with nuts so that they are suspended in mid-air at the center of each foundation hole.
- (6) Place a level on the flange surface to check the horizontality of the surface. If it is not horizontal, adjust it with metal wedges.
- (7) Once the horizontality and verticality are achieved, lay mortar into the foundation holes, the clearance under the common base, and the area around the common base. When the mortar has set completely after a few days, tighten the foundation bolts. (At that time, ensure to tighten the nuts evenly and gradually.)





- (8) Be sure to align the shafts correctly.

Although the shaft is aligned at the factory before shipment, it could get misaligned during transportation or installation (at fastening the anchor bolts). Check the alignment and re-align it after the installation is complete.

3.4 Coupling alignment procedure

 **Warning**  

Be sure to turn off the power switch before starting alignment. The pump may be unexpectedly activated and cause an injury.

 **Warning**  

Remove the shaft coupling cover when carrying out alignment. Before operating the pump, however, be sure to fit the cover back on. If the pump is operated without the cover, you may get caught in the machinery and injured.

 **Caution** 

Improper alignment may lead to machine damage, vibrations, or noise. Ensure to achieve accurate alignment.

Coupling application table

Model	Rated output	Coupling model	Coupling type	Development
LS2 LS2-e	5.5kW and less	CF-A-008	CF - A (Cylindrical hub)	Fig. 3.4.1-1
	7.5kW	CF-A-012	CF - A (Cylindrical hub)	Fig. 3.4.1-1
	11kW - 18.5kW	CF-A-022	CF - A (Spacer hub)	Fig. 3.4.1-2
	22kW and over	CF-A-028	CF - A (Spacer hub)	Fig. 3.4.1-2
LS LS-e	5.5kW and less	CF-A-008	CF - A (Cylindrical hub)	Fig. 3.4.1-1
	7.5kW	CF-A-012	CF - A (Cylindrical hub)	Fig. 3.4.1-1
	11kW - 15kW	CF-A-022	CF - A (Spacer hub)	Fig. 3.4.1-2
	18.5kW - 30kW	CF-A-028	CF - A (Spacer hub)	Fig. 3.4.1-2
	37kW and over	All sorts of AB	AB	Fig. 3. 4. 2
LM LM-e	Total output	All sorts of AB	AB	Fig. 3. 4. 2

3.4.1 Alignment (CF-A type coupling)

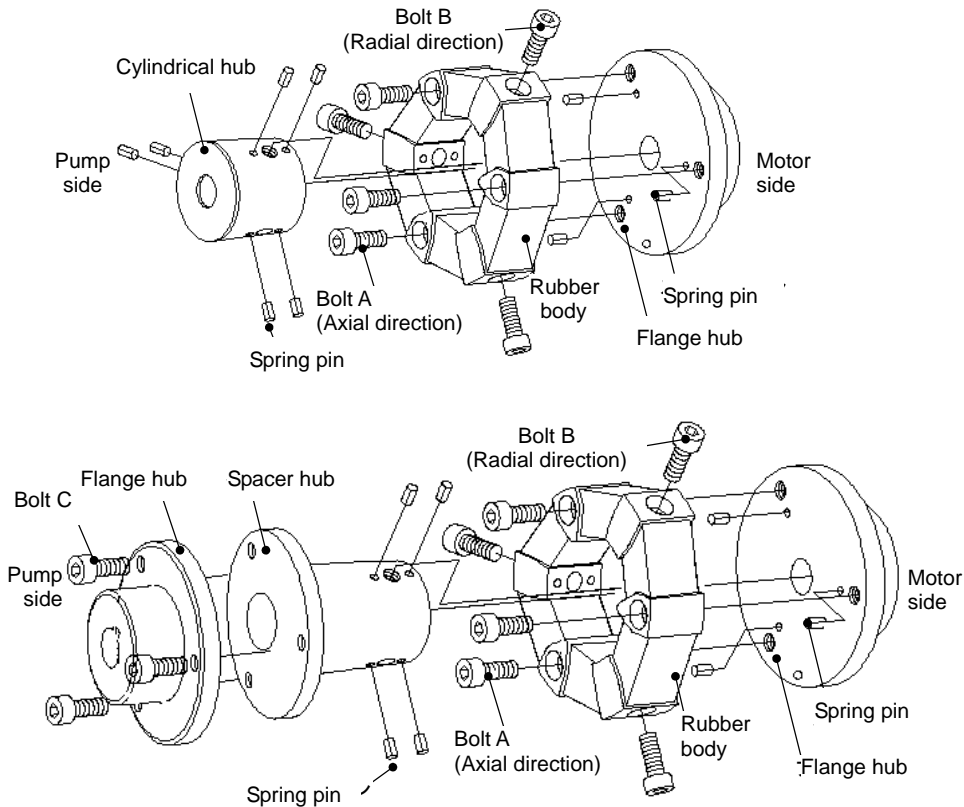

Fig. 3.4.1-2 CF-A (Spacer hub type)



The dimensions to push the cylindrical hub (spacer hub) and the flange hub against the shaft end change depending on the pump model. When removing the cylindrical hub (spacer hub) and the flange hub, make sure to check the dimensions to push them before disassembly. Also make sure to adjust the proper dimensions to push the hub.

- (1) Remove the bolt B (radial direction) and then remove the bolt A (axial direction).
- (2) If a rubber body is mounted on a cylindrical hub, it would make difficult to check the alignment. Keep the rubber body inserted in the pump shaft and slide it to the pump side.
For CF-A (spacer hub type), remove the bolt C and then remove the rubber body.
- (3) Perform the alignment work as accurately as possible adjust so that the difference between coupling centers is within the allowable value.
Use a dial gauge, a taper gauge, and a parallel ruler for precise measurements.

CF-A type allowable amount of misalignment

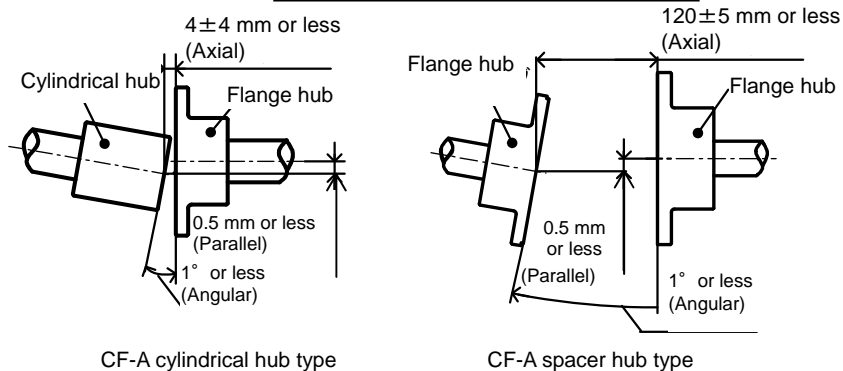

Coupling model	Allowable amount of misalignment			Bolt / Nut	
	Parallel ϵ (mm)	Angular θ°	Axial L(mm)	Size	Tightening torque (N·m)
CF-A-008	0.5	1	4±4	M10	49 – 54 (bolt A/B)
CF-A-012	0.5	1	4±4	M10	49 – 54 (bolt A/B)
CF-A-022	0.5	1	120±5	M12 M10	85 – 94 (bolt A/B) 49 – 54 (bolt C)
CF-A-028	0.5	1	120±5	M14 M12	130 - 150 (bolt A/B) 85 – 94 (bolt C)

- (4) After confirming that mounting misalignment is within the allowable amount, return the rubber body onto the cylindrical hub.

For CF-A (spacer hub type), tighten the bolt C to lock the spacer hub and insert the rubber body.

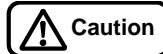

When mounting a rubber body on the cylindrical hub, wipe off the grease on the mounting surface. The oil composition might have adverse effects on the rubber body.

- (5) Check that the spring pin is firmly pushed into the cylindrical hub (spacer hub) and the flange hub.



Ensure that the spring pin is firmly pushed into the hub before mounting the rubber body. Failure to observe this may cause damage to the equipment or vibration and noise.

- (6) Assemble by first tightening the bolt A (axial direction) to lock the rubber body into the flange hub, and then tightening the bolt B (radial direction) to lock the rubber body into the cylindrical hub (spacer hub).

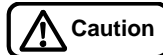

When mounting the rubber body onto the cylindrical hub (spacer hub), screw each bolt in by two threads each and then tighten. In case tightening either one bolt first, it might be unable to assemble them.

- (7) Tighten the bolts evenly with a torque wrench to the prescribed tightening torque.



In case tightening the bolt B (radial direction) to lock the rubber body into the flange hub first, the rubber body may be deformed due to the friction of bolt seat face. Make sure to tighten the bolt A (axial direction) first to lock the rubber body, and then tighten the bolt B (radial direction).

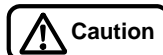

Bolts for mounting are given a microcapsule coating in blue color. Do not use any other type of bolts. Moreover, never use an anaerobic liquid adhesive because it might have adverse effects on the rubber body.

- (8) Install the shaft coupling protective cover.



Remove the shaft coupling cover when carrying out alignment. Before operating the pump, however, be sure to fit the cover back on. If the pump is operated without the cover, you may get caught in the machinery and injured.

- (9) When alignment is complete, pour mortar into the anchor bolt holes, the gap under the common bed, and the area around the common base. When the mortar has fully cured, tighten the anchor bolts.

3.4.2 Alignment (AB type coupling)

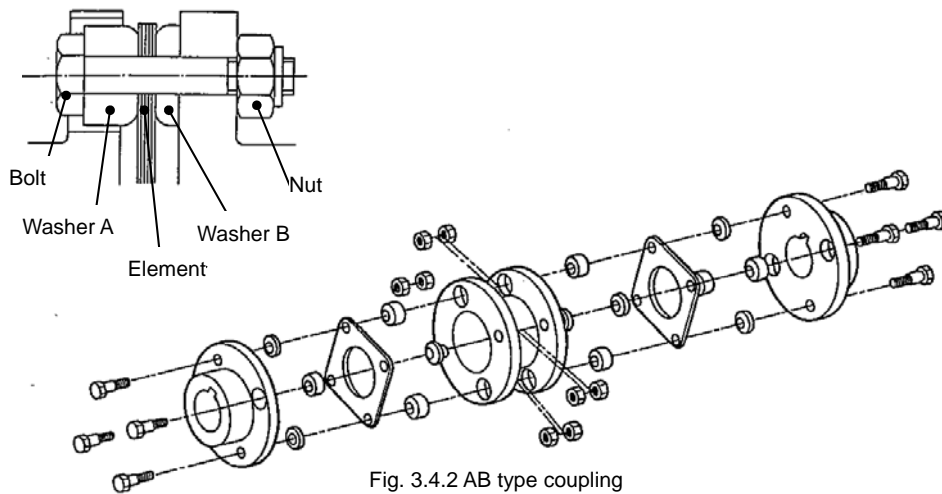
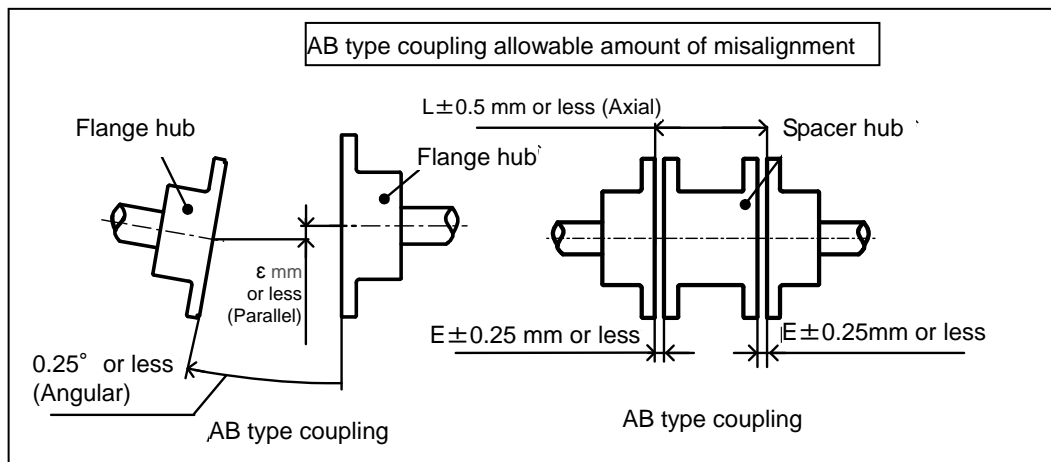

Fig. 3.4.2 AB type coupling

- (1) Loosen the nut and then remove the spacer hub.
- (2) Perform the alignment work as accurately as possible adjust so that the difference between coupling centers is within the allowable value.

Use a dial gauge, a taper gauge, and a parallel ruler for precise measurements.



Rated output	Coupling model	Allowable amount of misalignment				Bolt / Nut	
		Parallel ϵ (mm)	Angular θ°	Axial		Size	Tightening torque (N·m)
				L(mm) ± 0.5	E(mm) ± 0.25		
37kW, 45kW	AB-25ZN-140	0.5	0.25	140	11.7	M10	41.2
55kW	AB-30ZN-140	0.5	0.25	140	11.7	M10	71.5
75kW	AB-35ZN-140	0.5	0.25	140	16.8	M12	71.5
90kW - 132kW	AB-35ZN-180	0.7	0.25	180	16.8	M12	71.5

Note) The AB type coupling model corresponding to each rated output is a typical model. The coupling model is subject to change according to the pump specification.

- (3) After mounting misalignment is within the allowable amount, insert the washer A so that the curved surface of the washer A fits to the element. Next, insert the element.
- (4) Insert the washer A to the other bolts in a similar way. Next, insert the washer B from the spacer side so that the curved surface washer B fits to the element, and install the nut. Tighten the nuts alternately on opposite sides to ensure they are tightened evenly.



When mounting the spacer, the spacer must be supported in parallel so as not to damage the connected elements..

- (5) Tighten the bolts evenly with a torque wrench to the prescribed tightening torque.

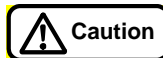

In case tightening torque is not uniform, the variation may occur in the gap (dimension E) between the spacer hub and the flange hub, which may damage the connected elements. Make sure to tighten the bolts evenly with a torque wrench.

- (6) Install the shaft coupling protective cover.



Remove the shaft coupling cover when carrying out alignment. Before operating the pump, however, be sure to fit the cover back on. If the pump is operated without the cover, you may get caught in the machinery and injured.

- (7) When alignment is complete, pour mortar into the anchor bolt holes, the gap under the common bed, and the area around the common base. When the mortar has fully cured, tighten the anchor bolts.

3.5 Precautions for piping work



Before piping work, remove the protective seals attached to the suction port and the discharge port of the pump. Running the pump with those seals attached may damage the pump and the piping.



Be sure to install a strainer at the suction port of the pump. Otherwise, the piping may be contaminated with foreign objects, thus damaging the pump and the piping.



Do not forcibly screw a pipe into the pump with the companion flange attached to the pump. The pump may be damaged.

- (1) Remove the protection seal attached to the suction side and the discharge side of the pump casing.
- (2) Be sure to provide pipe supports so that the weight of pipes is not applied directly to the pump main body.



Be sure to provide pipe supports for the pipes. Otherwise, the main shaft may be displaced from the center, thus leading to the equipment damage, vibration, or noise.

- (3) The suction pipe must be made as short and straight as possible.
- (4) Bends must be as far from the suction port of the pump as possible with maximum bend radius.
- (5) Carefully attach joints and other parts to the suction pipe to block air suction.
- (6) The suction piping should be corresponding to or larger in diameter than the pump port (a size larger as a guide). In case, for lifting operation, you use a suction pipe with larger diameter than that of the pump suction port, attach an eccentric reducer to prevent air from being trapped. Also if you use a suction pipe with smaller diameter than that of the pump, it may cause cavitation.

Note

For the models with pump suction diameter of 80, 100, and 125mm, the suction piping should be a size larger in diameter than the pump. If you use a suction pipe with smaller diameter than that of the pump, it may cause cavitation.

Pump port diameter	Suction pipe diameter
80mm	100mm
100mm	125mm
125mm	150mm

- (7) For boost operation
 - Be sure to attach a sluice valve to the suction pipe.
 - Install a strainer at the suction side of the pump to block the entrance of foreign matter and other objects (such as cutting chips, sand, rust, and scale) to the pump. (Recommended mesh size for the strainer: 40 mesh for normal use, 80 mesh for cleaning)

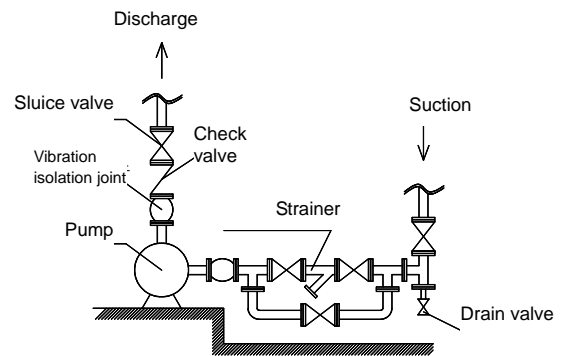

Construction example

(8) For lifting operation

- The suction pipes should be as short as possible with minimum bends. Do not attach a sluice valve to the suction pipes. Do not install the piping with a shape of upward bend (i.e. providing the piping with a rising gradient and then a descending gradient).
- To prevent air from being trapped inside the suction pipe, provide a rising gradient (at least 1/100 degrees) leading up to the pump.
- If you use a suction pipe whose bore is larger than that of the suction port of the pump, use an eccentric reducer to prevent air from being trapped. The diameter of the suction pipe can be up to 2 sizes larger than that of the pump. (e.g. If the suction port bore of the pump is 40A, the suction pipe bore must be 50A or 65A.) If the diameter of the suction pipe is too large, the foot valve might not open or bubbles may easily generate inside the suction pipes due to the increased amount of the dissolved oxygen.
- Attach a foot valve with a strainer to the end of the suction pipe to prevent entry of foreign objects. Immerse the foot valve in water and set it at a depth of at least twice the diameter of the pipe from the surface of water to prevent the suction of air. In addition, ensure that it is set above 500 mm or more from the bottom of water.

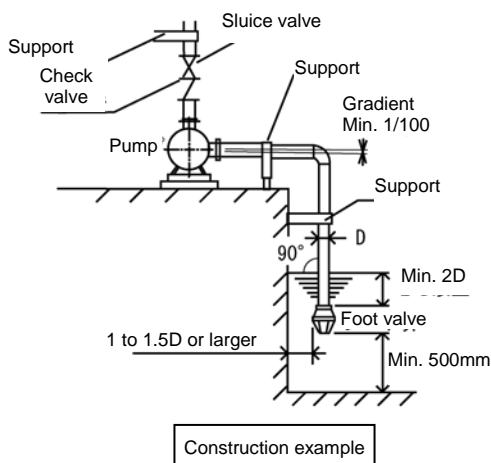

In case of using a foot valve:

- Properly install the foot valve vertically. If the valve is not vertical, it does not open or close properly, which comprises the function of the foot valve.
- Immerse the foot valve in water and set it at a depth of at least twice the diameter of the pipe from the surface of water to prevent the suction of air. In addition, ensure that it is set above 500 mm or more from the bottom of water.

- (9) Attach a sluice valve and a check valve to the discharge pipes. If water hammer may occur, attach a buffer type check valve.
- (10) If there is an upward curve in the discharge pipe, ensure that air can be vented from the section.
- (11) If two or more pumps are used for lifting operation, every pump should have its own separate suction piping.



If two or more pumps are used for lifting operation, every pump should have its own separate suction piping. Otherwise, air may be sucked from the inactive pump during single-pump operation, thus preventing water from being pumped.

- (12) If you take heat insulation measures for the pump, be sure to avoid the motor section. Otherwise, the motor may heat up and ignite. Furthermore, since the mechanical seal needs to be replaced periodically, install detachable insulation for it.





Never install heat insulation to the motor section. Otherwise, the motor may heat up and ignite.

- (13) On completion of the piping work, be sure to clean the inside of the receiver tank. Pay attention not to contaminate the system with foreign matter.
- (14) The shaft could get misaligned during installation due to the piping weight or fastening work of anchor bolts. Check the alignment and re-align it after the installation is complete, referring to “3.4 Coupling alignment procedure.”





Caution

Improper alignment may lead to machine damage, vibrations, or noise. Ensure to achieve accurate alignment.



3.6 Precautions for wiring work

Warning



Use high-quality wiring equipment and devices, and carry out wiring work safely and securely according to the technical standards for electrical facilities, as well as the indoor wiring regulations. Only qualified personnel such as licensed electrical engineers are allowed to carry out electrical wiring work. Unqualified persons are prohibited by law to carry out wiring work, and it is very dangerous.

Warning



Securely connect the terminals of the power cable. Loose terminals may cause the motor to run in open-phase condition, thus leading to motor burnout.

Warning



Be sure to install a ground fault interrupter dedicated to the unit for the power supply source. Failure to observe this may cause electric shock or fire.

- (1) Be sure to install a ground fault interrupter and an overload protection device on the primary power side of the pump.
 - * When switching from an IE1 motor-equipped product, it is necessary to verify the applicability of its ground fault interrupter and overload protection device. The starting current of Top Runner efficiency (equivalent to IE3) motor-equipped products tends to become higher than that of standard efficiency (IE1) motor-equipped products. If you have any questions, contact your nearest office of Teral.

Note

When switching from an IE1 motor-equipped product, it is necessary to verify the applicability of its protection device on the primary side of the pump. Failure to observe this may cause the protective device to trip on startup.

- (2) Be sure to attach a ground wire to prevent an electric shock. Connect the ground wire to the ground terminal inside the terminal box of the motor.



Be sure to attach a ground wire to the motor and perform grounding work.



Connecting a ground wire to gas pipe or water pipe is illegal and extremely dangerous.

- (3) Pass the power cable through a metal tube or a metal conduit for shielding, and connect a ground wire to the outer surface of the tube.



Do not install two or more different cables or control wires in one pipe or duct.

- (4) Limit the fluctuations of the supply voltage within $\pm 10\%$ of the rated voltage, and also limit the fluctuations of the frequency between -5% and $+3\%$ of the rated value. Although you can run the pump in these ranges, avoid continuous operation if the voltage is not within $\pm 5\%$ of the rated value or if the frequency is not within $\pm 2\%$ of the rated value.

Even if the power fluctuations fall within the allowable ranges, the pump characteristics, motor characteristics, and the temperature rise of the motor may differ from those at the rated voltage and frequency.

- (5) Precautions for using the inverter drive

- Ensure that the electric current during operation does not exceed 90% of the rated value.
- Ensure that the minimum frequency is set to 20Hz.
(Contact us if you need to run the drive at 20Hz or lower.)
- Do not use the inverter to drive a motor equipped with a self-protecting device.
- When driving a 400V-class motor, contact your nearest office of Teral. In some cases it might be necessary to take measures for inverter surge.
- An inverter-driven motor generates a magnetic sound which may be annoying compared with the drives using commercial power supply.
- Although this magnetic sound does not adversely affect the quality of the motor, some inverters allow the user to adjust the tone by changing the carrier frequency. However, changing the frequency may reduce the allowable output of the inverter. Pay particular attention when selecting the inverter.
- If the pump and motor produce resonance during normal operation, do not run them in the range of the rotation speed.



Do not run the pump at a frequency exceeding 60 Hz (50 Hz for models dedicated to 50Hz). Failure to observe this may overload the motor, causing it to burnout. If the models dedicated to 60Hz are run at 50Hz, the performance will deteriorate.

4. Operation

4.1 Check items before test operation

4.1.1 Check items related to the electrical system



Before changing the wiring, be sure to turn off the main power supply. Otherwise, you may receive an electric shock.



Do not use the product at any voltage other than the rated value. A fire or electric shock may occur.

- (1) Check that the equipment is correctly wired.
- (2) Check that the terminals are securely connected.
- (3) Check that the equipment is securely grounded.
- (4) Check that the setup value of the overload protection device is consistent with the rated current value of the motor.

4.1.2 Check items related to the pump



Do not put a cover or a filter over the motor. The temperature may rise inside the motor, thus leading to failures.



Do not allow a large amount of foreign matter to enter the pump. Failure to observe this may cause damage to the sliding parts (e.g. bearings) inside the pump, leakage or unusual noise.



Ensure that a strainer is installed at the suction side of the pump (Recommended strainer mesh: 40 mesh for normal use, 80 mesh for cleaning). Foreign matters may enter the pump and cause damage to the sliding parts (such as bearings, mechanical seal) in the pump, leakage or unusual noise.

- (1) Check that the gland packing is correctly installed.
- (2) Be sure to close the sluice valve on the suction and discharge sides of the pump to drain the water inside the pipes by natural drainage or other methods.
- (3) Rotate the pump shaft by hand to check smooth rotation. Grip the coupling or the shaft by hand to rotate the shaft. If the rotation is stiff or not uniform, there may be some rust or foreign matter inside the pump. Inspect the pump in such a case.



Before rotating the main shaft by hand to check it, be sure to turn off the main power. An unexpected start of the pump may cause an accident.

- (4) If the sluice valve is installed on the suction side, fully open the valve.
- (5) Prime the pump until water overflows from the priming funnel or the priming port. At that time, loosen the air vent cock to release air from the pump.



When priming the pump (air venting), prevent the damage of the motor and parts from the spouting water. When you pump hot water, be careful not to get burns.



For pumps circulating heated water, do not carry out the above procedure with bare hands because hot water may spout out of the air vent cock, thus leading to burns.



Never run the pump dry (operation without priming). Failure to observe this may cause the sliding parts inside the pump to seize up.

- (6) Check that the alignment of the shaft. Re-align it, if necessary, referring to “3.4 Coupling alignment procedure.”

4.2 Running the pump (test operation)



Do not operate the pump if any abnormal condition is observed or if there is anything wrong with the parts, components, and others during the check before test operation. Failure to observe this may cause an injury, failure, accident, or other problems.



Be sure to put a shaft coupling protective cover during operation. Failure to observe this you may cause an injury.



Be sure to attach the cover of the terminal box of the motor. Failure to observe this may cause an electric shock.



If the liquid used exceeds 40°C, do not touch the pump. Failure to observe this may cause an electric shock.



Do not run the pump dry, and do not allow a large amount of air or foreign matter to enter the pump. Failure to observe this may cause damage to the sliding parts (bearings, etc.) inside the pump, disability of pumping, leakage or unusual noise. It may also heat the pump, thus leading to burns.

- (1) Check the rotation direction of the pump by turning ON and OFF the power switch once or twice. Normal rotation is clockwise when viewed from the motor side.

If the pump shaft rotates in reverse, swap two of the three wires of the power cable.



Never check the rotation direction by running the pump dry. Running the pump dry even for a short time may cause damage to the sliding parts (e.g. bearings, mechanical seal) inside the pump, leakage or unusual noise.



Do not run the motor in reverse because it may cause a failure.

- (2) Turn on the power to start the pump.
- (3) During the initial period of pump operation and circulation, gradually open the sluice valve on the discharge side to circulate liquid at a flow rate (flow velocity) higher than the normal operation. After this circulation cleaning is complete, clean the strainer.
- (4) Adjust the sluice valve on the discharge side so that the specified pressure is achieved.



Do not perform long hours of no-discharge operation continuously. Failure to observe this may increase the temperature in the pump, resulting in an unexpected failure.

- (5) As a guide, limit the frequency of the startups and shutdowns to about five times an hour.



Minimize the frequency of startups and shutdowns of the pump because frequent startups and shutdowns may damage the pump sooner than usual. Do not start the pump more than five times an hour or so.

- (6) In the event of a power failure during operation, be sure to turn off the power.



In the event of a power failure, be sure to turn off the main power. The pump may suddenly start up on restoration of the power, thus leading to an injury.

- (7) Before restarting the pump, confirm that the pump has completely stopped.



Before restarting the pump, be sure to check that the pump has completely stopped. Turning on the power while the pump is still rotating causes an excessive torque on the pump and may cause a failure.

- (8) Check for any abnormal pressure, electric current, vibration, noise, and other conditions. Refer to the following chart for the “vibration vs. rotation speed.” (If you install the pump on a vibration isolator, the standard vibration values are different from those in the following chart. Contact us in such a case.)

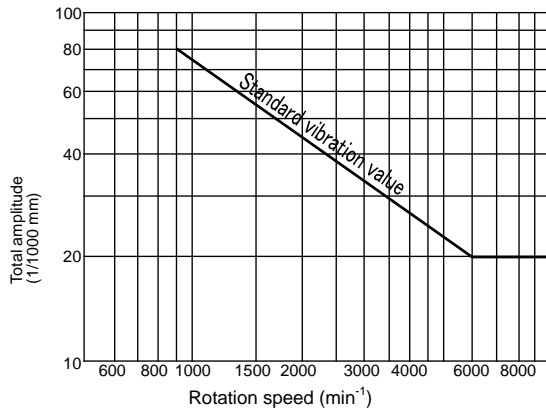

Standard vibration value at the bearing section

[For reference only]

Relation between the total amplitude (a) and the vibration velocity (V)

$$a = \frac{V \times 4 \times 10^4}{\pi \times n}$$

a: Total amplitude (μm)
 V: Vibration velocity (mm/s)
 n: Equipment rotation speed (min⁻¹)

- (9) Stop the pump.



Warning

Do not put your fingers or other objects into the opening of the motor. Otherwise, it may lead to an electrical shock or injury.



Caution

Keep the cocks of the pressure gauges, compound pressure gages, and other parts closed all the time except when they are used for measurement. Otherwise, they become more susceptible to failure.



Caution

Do not run the pump using the power beyond the allowable current value. Otherwise, the motor may burn out.

5. Maintenance and inspection



Before checking the pump, be sure to turn off the main power. The pump may suddenly start up in automatic mode or on other occasions and lead to a great danger.



Before starting the unit or carrying out maintenance/inspection work, ensure that all the relevant workers are informed of the operation and that there are no workers in the dangerous zone.

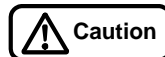

For overhaul, replacement of parts, or repairs, ask the vendor, the servicing company specified by Teral, or your nearest Teral sales office. Incorrect work may cause a failure or accident.

5.1 Precautions for maintenance and inspection



(1) Observe the following instructions, in particular, during daily inspection.

- ① A large deviation in the pump's discharge pressure, electric current, vibration, noise, or other conditions from the normal status is a sign of an imminent failure. Therefore, immediately take measures, referring to the Maintenance checklist in Section "5.4 Maintenance checklist."
For this purpose, it is recommended to keep an operation log.
- ② If the bearing temperature gets abnormally high, immediately stop the pump and check the bearing. The temperature is normal if the temperature difference between the bearing case surface near the bearing and the atmosphere does not exceed 40°C.
- ③ Replace the bearings if they generate unusual noise or vibration.
- ④ An oil seal is installed to block the water entry into the bearing section. Replace it at the same timing to replace the bearing.
- ⑤ If gland packing is used as a shaft seal, check that the gland packing housing does not generate heat abnormally. If the drip rate is too small, it might generate heat abnormally. Even after tightening the nut of the packing retainer, the drip rate cannot be adjusted, replace the gland packing or both the gland packing and the main shaft. Refer to "5.2.1 Gland packing" for details.
- ⑥ If mechanical seal is used as a shaft seal, high-frequency sound (mechanical squeak) may be generated occasionally, but it is not a pump failure. You can continue to use the pump with the same good quality.
- ⑦ Normally, if mechanical seal is used as a shaft seal, liquid leakage hardly occurs. If liquid leakage becomes frequent, replace the seal. (At the time of initial period of operation, a small amount of leak may occur, but it is not a pump failure. The leak should stop in several overheat of operation.) For details, refer to "5.2.2 Mechanical seal."
- ⑧ Check the piping for any water leakage or damage.
- ⑨ Check that all mounting bolts and the power terminal block are securely connected.
- ⑩ Except when inspection is required, keep the cocks of the pressure gauges and compound gauge closed all the time with the pressure being released.
- ⑪ In the event of a power failure, be sure to turn off the power. The pump suddenly starts up on restoration of the power, and it is dangerous.



In the event of a power failure, be sure to turn off the power switch. The pump may suddenly start up on restoration of the power, which leads to a danger.





- ④ Check the strainer fitted on the pump suction side, for any clogging. Clean it if it is clogged.

Caution

Periodically clean the strainer located on the pump suction side. A clogged strainer may cause pressure fluctuations, a lower discharge rate, abnormal noise, and other problems, thus leading to a pump failure.

(2) If you do not use the pump for a long time, observe the following points.

- ① To prevent possible freezing inside the pump in winter, be sure to take antifreeze measures such as heat insulation or the installation of a heater to the pump or completely drain the pump.
- ② If gland packing is used for shaft sealing, the shaft seal part may be rusty when the pump is not used for a long period of time. Remove the gland packing, dry away all moisture from the shaft, apply grease for rust prevention and install a new gland packing.
- ③ If mechanical seal is used for the shaft, its sliding surface may become sticking in place, thus making it difficult to rotate the shaft smoothly. Therefore, periodically run the pump to maintain its smooth rotation. Moreover, before running the pump, turn the pump shaft by hand to check its smooth rotation.





Warning



Before turning the pump shaft by hand to check its smooth rotation, be sure to turn off the main power. Otherwise, the pump may start unexpectedly, thus leading to an accident.

- ④ If you have a backup pump, run it from time to time to make it available for operation at any time.

5.2 Shaft seal parts

5.2.1 Gland packing

Caution

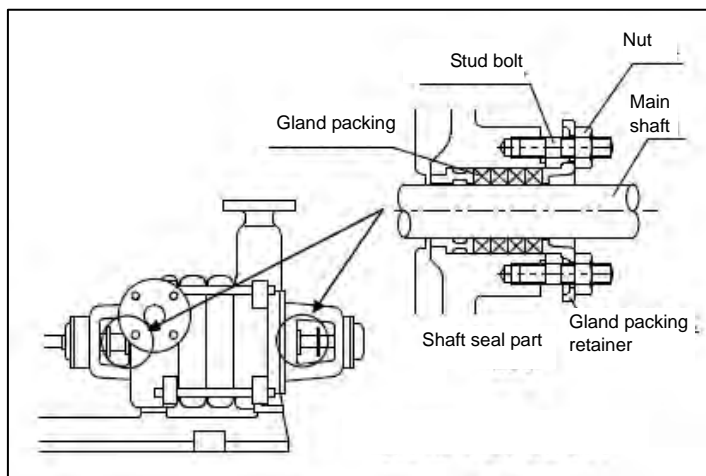

Be careful not to tighten the gland packing excessively or unevenly. Otherwise, it may cause excessive heating of the shaft seal part, or damage to the gland packing and the main shaft.



- (1) Adjust the drip rate from the gland packing as shown the table below. Do not carry out this adjustment during the initial period of pump operation. If the gland packing is excessively heated, or drip rate is too small, loosen the gland nut.

Pump suction inlet diameter	Standard drip rate from the gland packing (as a guide)
65 mm or less	10 to 20 [cc/min]
80 mm or over	15 to 30 [cc/min]

A drop of water that drips out of the gland is about 0.05cc.

20cc/min: The drip amount of the water of the degree that falls as droplets or like thread

The drip rate is subject to change according to the operating conditions.

- (2) If the drip rate is not reduced sufficiently after 30 minutes of the initial operation, tighten the gland nut gradually and evenly, while paying attention to heating of the packing.
- (3) The drip rate increases gradually over time. When it reaches roughly twice the value in the table, retighten the gland nut.
- (4) Eventually, it will not be possible to tighten the packing retainer any further. When this happens, replace the packing.
- (5) Insert the gland packing rings carefully one by one, as far as it will go. In addition, the rings should be oriented so that each of their adjacent cut slits will be 90 to 120 degrees apart.
- (6) Gland packing is a consumable part. Its life depends on the quality of liquid, having foreign objects or no, pressure, etc.

5.2.2 Mechanical seal

- (1) The mechanical seal is a precision part for preventing water leakage from the clearance of the pump shaft. Carefully handle the seal to ensure the proper operation of the pump.
- (2) The mechanical seal is a consumable. It wears at a different rate depending on the properties of circulating liquid, the presence of foreign matter, operating pressure, and other factors; and the service life changes accordingly
- (3) If there is any water leakage at the mechanical seal, replace it.

During the initial period of running a new pump, a small amount of leak may occur until the sliding surfaces on the mechanical seal completely settle (or fit) into place, and the leak should stop in several hours of operation. Since this initial leak does not mean a defect of the mechanical seal, you can normally use the pump.

5.3 Bearings

- (1) The bearing used for the pump is oil bath type. Pour in oil until the oil level reaches the center of red-circle of the oil gauge. Do not run the pump when the oil level goes above the red-circle. If the oil level is too low, the bearing may be seized up. Also if the oil level is too high, oil may leak from the bearing.
- (2) Use Turbine oil #32.
- (3) Oil should be replaced with new oil every 10,000 hours operation. Oil should be replaced at least every two years even if the pump has operated for less than 10,000 hours.

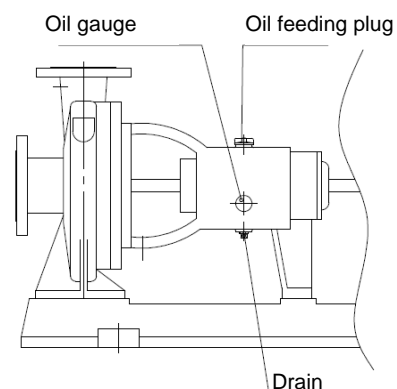

- (4) An oil seal is installed for the purpose of sealing oil. The oil seal is a consumable part. When oil leakage is increasing and when exchanging a bearing, replace it with a new one. The service life of oil seal will greatly depend on a surrounding environment and influence of heating liquid temperature.
- (5) Make sure to prevent water from directly entering into the air vent hole in an oil feeding plug.

5.4 Maintenance checklist

Item	Inspection point	Inspection item	Inspection method	Criterion (Reference page)	Inspection interval				Consumables Timing of replacement (as a guide)*
					Daily	Monthly	Half-yearly	Yearly	
Ambient conditions	Temperature	Check against the specified range.	Measure	Between 0 and 40°C (2-2)	✓				-
	Humidity		Measure	Less than 85% RH (2-2) (no condensing)	✓				-
	Dust and other contaminants		Visual check	No dust or other contaminants	✓				-
Power	Power terminal block	Voltage	Measure	Specified voltage (2-2)			✓		-
		Voltage fluctuation	Measure	Within the allowable fluctuation range (2-2)			✓		-
		Loose screws	Retighten	Securely tightened				✓	-
Pump and motor	Operation condition	Performance	Visual check	As per the specifications	✓				When abnormality is recognized, disassemble and inspect the pump.
		Current value	Measure	As per the specifications	✓				
		Noise, vibration	Listen, Touch	No abnormal vibration	✓				
	Impeller	Clogging	Disassemble and inspect	No clogging				✓	
		Wear	Disassemble and inspect	No abnormal condition				✓	When worn out and performance is deteriorated
	Liner ring	Wear	Disassemble and inspect	No abnormal condition				✓	When worn out and performance is deteriorated
	Main shaft and its surrounding area	Smooth rotation	Rotate by hand	Rotation is smooth and uniform				✓	-
	Bearing	Heat-generation, noise, vibration	Touch, Listen, Visual check	No abnormal condition(5-1)				✓	Every three years (or after 15000-hours operation)
		Oil supply (pump)	Visual check, Listen	No abnormal vibration or noise. No leakage				✓	Refer to 5.3 for oil supply
	Oil seal	Leakage	Visual check	No leakage				✓	Every 2-3 years (at the timing to replace bearing)
	Gland packing	Leakage	Retighten	Proper drip rate (5-2)	✓				Every 6 months (or after 2000-hours operation)
	Mechanical seal	Leakage	Visual check	No leakage (5-3)		✓			Once a year (or after 8000-hours operation)
	Coupling rubber	Deterioration, wear	Visual check	Abnormal abrasion No deterioration		✓			Rubber body: Every 3-5 years
	O-ring, packing	-	-	-					Whenever disassembled
	Appearance	Unusual noise, vibration	Visual check, Listen	No abnormal condition	✓				-
Winding resistance	Resistance value between each winding (U-V, V-W, W-U)	Measure	Resistance value is uniform between the windings				✓	-	
Insulation resistance	Between the ground and each lead wire	Measure	1 MΩ or more (by DC500V Megger tester)				✓	-	

* The timing of replacing consumables (as a guide) does not mean their guaranteed service life. The service life of parts varies depending on the ambient conditions and the conditions for use.

Note

The timing of replacement for the consumables is the reference values when normally used and checked regularly. It may become short according to the use condition.

Note

Dispose of the waste components generated by the repair or the replacement according to the local regulations, by asking the specialized waste disposal contractor.

6. Troubleshooting

If you find any abnormal conditions of the pump, carefully investigate the problem. For overhaul, replacement of the parts or repairs, ask the vendor or contact Teral or our servicing companies.

Problem	Cause (Reference page)	Action (Reference page)
The pump does not start.	Wiring is disconnected or broken.	Check the wires and connections to repair or replace.
	Poor connection or contact of power wires (3-11)	Check by a tester and replace the defects with a good one if any.
	The power fuse is blown.	Replace it with an appropriate fuse.
	Tripping of the thermal relay	Check the thermal relay.
	The power voltage is too low. (2-2)	Check the power voltage and contact the power company.
	The motor has failed.	Contact Teral or our servicing companies because disassembly and inspection are required.
	Foreign matter is caught in the impeller.	
	The shaft seal is bound.	
The bearing is rusty.		
The pump starts, but cannot achieve the specified discharge rate and the specified head.	The priming in the casing is not enough. (4-1)	Fully prime the water.
	The pumping liquid contains many bubbles.	Prevent the formation and suction of bubbles.
	The air intrudes from the suction piping.	Check the joint of each suction piping.
	The rotation direction is reverse. (4-3)	Correct the wiring so that the motor rotates in normal direction. (4-3)
	The piping loss is high.	Check the diameter, route and length of the pipes.
	The piping is clogged with foreign matter.	Check and clean the piping.
	The impeller and the liner ring are worn.	Contact Teral or our servicing companies because disassembly and inspection are required.
	Foreign matter is accumulated in the impeller and in the casing.	
	The rotation speed is low.	Check with the tachometer.
	The sluice valve is closed. (4-3)	Open the sluice valve.
	There is a leak in the discharge pipe.	Check and repair the pipe.
	The total suction head is too high. (3-1)	Consult us or our servicing companies.
Overload and overcurrent of the motor	The rotation speed is too high.	Check with the tachometer.
	The stator winding is broken, shorted, or grounded.	Contact Teral or our servicing companies because disassembly and inspection are required.
	The stator and rotor are in contact due to wear of the bearing.	
	The motor is running in open-phase condition.	Check the wiring.
	The setting of overload protection device is too low.	Correctly set the motor overload protection device.
	The power supply voltage is out of the allowable fluctuation range.(2-2)	Check the voltage and contact the power company.
	A 50Hz pump is run in the 60Hz power zone.	Check the nameplate.
	The discharge rate is high.	Throttle the sluice valve to adjust the rate as per the specifications.
	A rotating part is in contact with another part.	Contact Teral or our servicing companies because disassembly and inspection are required.
	Foreign objects enter into the pump.	
	The gland packing is excessively tightened. (5-2)	Properly adjust the drip rate from the gland packing. (5-2)

Problem	Cause (Reference page)	Action (Reference page)
Overheat of bearing	The bearing is worn or damaged. (5-1)	Contact Teral or our servicing companies because disassembly and inspection are required.
	The oil is leaking.	
	The oil level is low or the oil is deteriorated.	Replenish the oil. (5-3)
	Incorrect installation of the pump and the piping, misalignment of the shaft (3-1)	Check and correctly install or realign them.
Unusual noise and unusual vibration of the pump	The bearing is worn or damaged. (5-1)	Contact Teral or our servicing companies because disassembly and inspection are required.
	The impeller is clogged with foreign matter, thus leading to imbalanced load.	
	The main shaft is winding.	
	Abnormal noise from the shaft seal (mechanical seal).(5-1)	
	The motor is running in open-phase condition.	Check the wiring.
	Cavitation has occurred. (3-10)	Consult Teral or our servicing companies.
	Incorrect installation of the pump and the piping, misalignment of the shaft (3-1)	Check and correctly install or realign them.
	Inverter is used.(3-12)	Change the operating frequency or carrier frequency.
An abnormal amount of water is leaking from the shaft seal.	Damage to the mechanical seal (5-1)	If the leakage becomes large, replace the seal. (5-1) Contact Teral or our servicing companies because disassembly and inspection are required.
When the power is turned off, the pump rotates backward.	Foot valve or check valve is damaged.	Inspect and replace the foot valve and check valve.
	The suction pipe leaks the liquid.	Inspect and repair the pipes.

TERAL
TERAL INC.

Head Office

230, Moriwake, Miyuyki-cho, Fukuyama-city, Hiroshima, 720-0003, Japan
Tel.084-955-1111 Fax.084-955-5777

Overseas Div.

TERAL Koraku Bldg., 2-3-27, Koraku, Bunkyo-ku, Tokyo, 112-0004, Japan
Tel.03-3819-6890 Fax.03-3818-6790